

TROPICAL

SELL SHEET

TROPICAL FOREST PRODUCTS
BOARDWALK DECKING

Tropical Forest Products Boardwalk and Bridge Decking



Atlantic City, New Jersey - Ipe



Long Beach, New Jersey - Ipe

Wood Vs Non-Wood?

Timber boardwalks demonstrate the lowest MKI (environmental cost indicator) of all bridge construction types. But don't take our word for it. The Dutch Government conducted a comprehensive study in 2014 to evaluate the environmental impact of various building materials. Here are the results of that study.

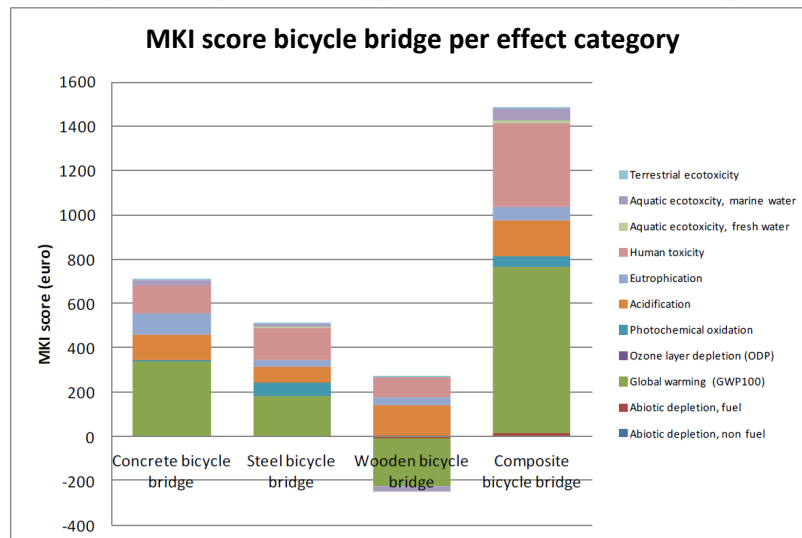

TROPICAL

SELL SHEET

TROPICAL FOREST PRODUCTS
BOARDWALK DECKING

Under USGBC / LEED Rating System SSc7.1 Exemplary Performance threshold of 100%, requires a minimum solar reflective index (SRI) of 29.

Ipe Wood (Un-weathered - Brown) has a Solar Reflective Index (SRI) of 36 (Average).

Ipe Wood (Weathered Grey) has a Solar Reflective Index (SRI) of 45 (Average).

Ipe Wood has a very dark brown color which occurs naturally.

Itauba, Cumaru and Thermally modified Woods having similar color and weathering characteristics to Ipe will generate similar solar reflective Index (SRI) as Ipe.

Garapa Wood having light golden color will have a higher solar reflective index than the darker wood species upon installation and a similar solar reflective index (SRI) upon weathering.

Heat Retention

Wood Decking has a 20-30% lower heat retention than composite decking products, not to mention significantly superior structural qualities. This improves both comfort and safety over non wood material options.

Ocean City-Ipe vs Alternative

Structurally, and from a durability standpoint, the Ipe hardwood is unparalleled.

“Ipe is highly recommended for use in boardwalk decking applications by the International Wood Products Association, and it is recommended by the City's engineering consultant for the 8th Street to Moorlyn Terrace.”

In a word, the performance of Ipe hardwood has been outstanding.



**Southern Yellow Pine after
5 years Atlantic City**

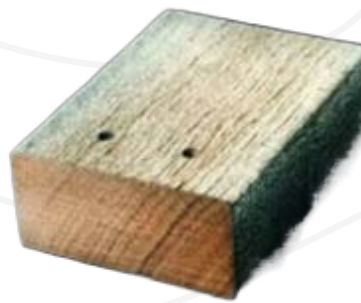

**Ipe after 30 years
Atlantic City**

TROPICAL

6200 Tomken Rd Mississauga, ON - L5T 1X7 - Canada
1-855-344-4500 | www.TropicalForestProducts.com | info@tropicalforestproducts.com
© All Rights Reserved - Tropical Forest Products 2023



LEGAL LUMBER  **TM**



TROPICAL

SELL SHEET

TROPICAL FOREST PRODUCTS
BOARDWALK DECKING

U.S. Army Corps of Engineers

SUBJECT: Impracticality of non IPE lumber for Boardwalk Decking

1. The purpose of this memo is to provide clear evidence and justification for the necessity of specifying IPE/Bethabara/Cumaru/Macaranduba tropical hardwood lumber species for Boardwalk decking.

The following is a summary of current materials and their availability suitable for commercial boardwalk specifications. All of the materials discussed are readily available and certified under our comprehensive Legal Lumber™ compliance program. Some of the wood species listed are available with FSC certification for LEED/USGBC based specifications. All wood species discussed are available FEQ or Premium Select Grade qualities. FEQ is typically specified for Commercial Decking and Premium Select for Posts and Rails. All the wood species discussed are Class 1 Durability and Class A Fire Rated. All wood species listed pass U.S. Building code requirements for slip resistance and have on average a 20% lower heat retention than plastic or composite decking with one exception which we shall talk about shortly.

Tropical Forest Products Ipe

Ipe – *Tabebuia* spp (Lapacho Group) remains the premier exterior hardwood species having the highest natural resistance to termites and marine borers combined with a dimensional stability green to dry over any other species available. Ipe continues to be readily available in a broad range of nominal and rough dimensions ranging from 1x4 all the way up to 4x12 and lengths up to 20', free of heart center and free of sapwood.

Sourcing large volumes of fixed dimensions and lengths in Ipe remains a challenge and virtually impossible in longer lengths. Designers should develop specifications that allow the use of random lengths 6' to 20' in order to facilitate reliable supply and lowest cost.

Optimal net dimensions for Ipe boardwalk decking are as follows:

Air Dried 1x3.5, 1x5.5, 1.5x3.5, 1.5x5.5, 1.5x7.25, 2.5x5.5, 2.5x7.25, 2.5x11.25, 3.5x5.5, 3.5x7.25, 3.5x11.25.

Note: When specifying for poorly ventilated decks always specify greater thickness to width ratios such as 1x3.5, 1.5x3.5, 2.5x5.5, 3.5x5.5.

Note: Face Screwing is the only installation method recommended in commercial boardwalk applications.

Delivery typically begins from stocks and completes with 90 -120 days subject to project volume requirements.

While Ipe plays a significant role in the boardwalk industry it is not the only solution and it has some limitations. Several other wood species are equally recognized for their incredible performance in commercial and marine applications.



Hudson River Park NY - Ipe

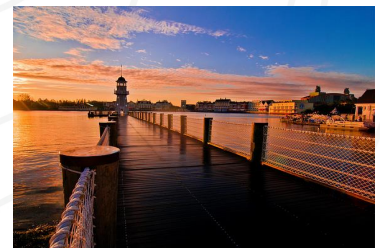

Disney Boardwalk Beach & Yacht Club Resort, Orlando, FL - Ipe

TROPICAL

6200 Tomken Rd Mississauga, ON - L5T 1X7 - Canada
1-855-344-4500 | www.TropicalForestProducts.com | info@tropicalforestproducts.com
© All Rights Reserved - Tropical Forest Products 2023



LEGAL LUMBER™



TROPICAL

SELL SHEET

TROPICAL FOREST PRODUCTS
BOARDWALK DECKING

Tropical Forest Products Cumaru

Cumaru (*Dipterix odorata*) continues to be readily available in a broad range of nominal and rough dimensions ranging from 5/4x6 all the way up to 12x12 and lengths up to 20', free of heart center and free of sapwood.

Cumaru is an excellent alternative to Ipe for commercial applications where it is not in direct contact with marine borers. Slightly less dimensionally stable than Ipe, greater thickness to width ratios improve performance.

Optimal net dimensions for decking as follows:

Kiln Dried 1x5.5, 1.5x3.5, 1.5x5.5, 12-18% Moisture Content to assure dimensional stability in application.

Air Dried 2.5x5.5, 2.5x7.25, 3.5x5.5, 3.5x7.25, 3.5x11.25. Moisture Content 18-25%

Note, When specifying for poorly ventilated decks always specify greater thickness to width ratio's, such as 1x3.5, 1.5x3.5, 2.5x5.5, 3.5x5.5.

Note: Face Screwing is the only installation method recommended in commercial boardwalk applications.

Cumaru is one wood species where it is still possible to specify large volumes of single dimensions and lengths which make it ideal for large commercial constructions. Designers are however encouraged to develop specifications that allow the use of random lengths, 6' to 20', in order to facilitate reliable supply and lowest possible cost.

Cumaru prices typically fall 10-20% below Ipe prices. Cumaru is also readily available as an FSC certified product with associated price premium.

Delivery is typically starting 90 days and completing with 150 -180 days subject to project volume requirements.

TROPICAL

6200 Tomken Rd Mississauga, ON - L5T 1X7 - Canada
1-855-344-4500 | www.TropicalForestProducts.com | info@tropicalforestproducts.com
© All Rights Reserved - Tropical Forest Products 2023



LEGAL LUMBER™



TROPICAL

SELL SHEET

TROPICAL FOREST PRODUCTS
BOARDWALK DECKING

Tropical Forest Products Ekki/Azobe

Ekki/Azobe (Lophira Alata) continues to be readily available in a broad range of nominal and rough dimensions ranging from 1.5"x3.5" all the way up to 16"x16" and lengths up to 39', free of heart center and free of sapwood.

Ekki is available both flat sawn for heavy timbers and decking and quarter sawn for smaller dimension decking, rails and site furnishings.

Ekki/Azobe is an excellent alternative to Ipe and is marine borer resistant. Somewhat less dimensionally stable than ipe, greater thickness to width ratios improve performance.

Optimal net dimensions for decking as follows:

Air Dried Moisture Content 20-25%

Nominal 1.5x3.5, 1.5x5.5, 2.5x5.5, 2.5x7.25, 3.5x5.5, 3.5x7.25, 3.5x11.25.

Net 2x4, 2x6, 2x8, 2x10, 2x12, 3x6, 3x8, 3x10, 3x12, 4x8, 4x10, 4x12, 6x12 Rough Sawn or Dressed S4S

Custom Any Dimensions and lengths up to 16x16x54' Rough or Surfaced.

Note: Face Screwing is the only installation method recommended in commercial boardwalk applications.

Ekki/Azobe is one wood species where it is still possible to specify large volumes of single dimensions and lengths which make it ideal for large commercial constructions. Designers are however encouraged to develop specifications that allow the use of random lengths, 6' to 39', in order to facilitate reliable supply and lowest possible cost. Ekki/Azobe prices typically fall 10-20% below Ipe prices. Ekki/Azobe is also readily available as an FSC Certified product with associated price premium.

Delivery is typically starting 90 days and completing with 120 -150 days subject to project volume requirements.

Some projects currently using Ekki/Azobe include the famous Statue of Liberty Island Pier, Duluth Aquarium Lakewalk, and other boardwalk and vehicular bridge constructions throughout the United States and Europe.

Also used for Boardwalk Stringers, Marine Piling, Marine Fenders, Sheet Piling, Crane Matts, Rail Road Ties and other high abuse applications Ekki/Azobe's amazing qualities are well known and well respected.



Liberty Island Pier and Boardwalk - Ekki



Duluth MN Aquarium - Ekki

TROPICAL

6200 Tomken Rd Mississauga, ON - L5T 1X7 - Canada
1-855-344-4500 | www.TropicalForestProducts.com | info@tropicalforestproducts.com
© All Rights Reserved - Tropical Forest Products 2023



LEGAL LUMBER™



TROPICAL

SELL SHEET

TROPICAL FOREST PRODUCTS
BOARDWALK DECKING

TFP Kebony

Kebonization is an enhanced wood technology. Through a process which infuses Radiata Pine with natural alcohols followed by thermal modification Radiata Pine a softwood is embodied with the characteristics of naturally durable hardwood species along with providing unparalleled stability in service.. TFP Kebony is readily available in nominal and rough dimensions. 5/4x4, 5/4x6, 5/4x8, 2x4, 2x6, 2x8 in 8', 10', 12', 14' and 16' lengths, free of heart center and free of sapwood.

TFP Kebony is an excellent alternative for commercial applications where it is not in direct contact with marine borers.

Note: Face Screwing is the only installation method recommended in commercial boardwalk applications.

TFP Kebony is one wood species where it is still possible to specify large volumes of single dimensions and lengths which make it ideal for large commercial constructions. Designers are however encouraged to develop specifications that allow the use of random lengths, 6' to 20', in order to facilitate reliable supply and lowest possible cost.

TFP Kebony prices are in line with naturally durable hardwoods and is an FSC certified product.

Delivery is typically starting 30 days and completing with 90-120 days subject to project volume requirements.

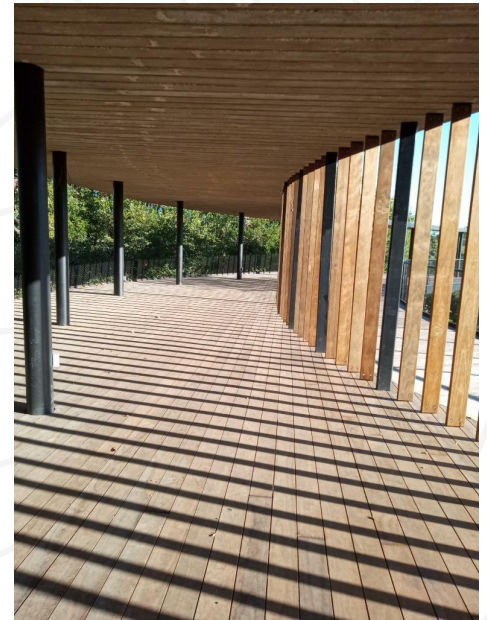

Springdale Green - Kebony

TROPICAL

6200 Tomken Rd Mississauga, ON - L5T 1X7 - Canada
1-855-344-4500 | www.TropicalForestProducts.com | info@tropicalforestproducts.com
© All Rights Reserved - Tropical Forest Products 2023



LEGAL LUMBER™



TROPICAL

SELL SHEET

TROPICAL FOREST PRODUCTS
BOARDWALK DECKING



Advanced Wood Technology Options

ThermoTech ASH

Thermally Modified ThermoTech ASH represents the application of advanced wood technology to the highest grade softwood for commercial application. Like all TFP Naturally Durable Hardwoods and Advanced Wood Technology Products, the elimination of chemical treatments means safety for the public and increased respect for the environment.

Tropical Forest Products ThermoTech Bamboo HD

High Density Thermally Modified Bamboo combines the rapidly renewable resource of species specific. Species of bamboo with thermal modification technology, organic polymers, heat and high pressure presses to create a board that has exceed the strength, hardness, fire resistance, termite resistance, rot resistance and slip resistance of naturally durable hardwoods with the stability associated with thermal modification technology.

The stability associated with this technology allows the use of board dimensions up to 2x12 without concern of cupping, warp or twist. Perfectly straight High Density ThermoTech Bamboo generates significant reductions in installation time as boards will never require straightening and less fasteners are required when wider widths are employed.

The only limit associated with ThermoTech Bamboo HD is the length structure. The product is produced in 6' or 8' lengths only at this time, though the product can be scarf jointed to create longer lengths. The incredible strength properties do allow the product to cantilever without deflection farther than any wood product. This strength means significantly higher loads can be supported verses other materials of similar dimensions.



ThermoTech Bamboo



ThermoTech Bamboo

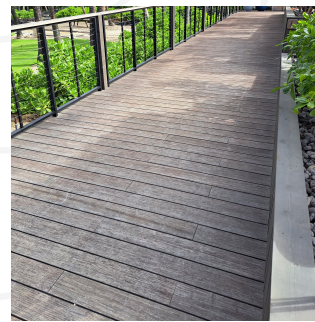

ThermoTech Bamboo

ThermoTech SYP

Thermally Modified ThermoTech SYP Clear represents the application of advanced wood technology to the highest grade softwood for commercial application. Like all TFP Naturally Durable Hardwoods and Advanced Wood Technology Products, the elimination of chemical treatments means safety for the public and increased respect for the environment.

TROPICAL

6200 Tomken Rd Mississauga, ON - L5T 1X7 - Canada
1-855-344-4500 | www.TropicalForestProducts.com | info@tropicalforestproducts.com
© All Rights Reserved - Tropical Forest Products 2023



LEGAL LUMBER™



TROPICAL

SELL SHEET

TROPICAL FOREST PRODUCTS
BOARDWALK DECKING

Thermotech Radiata Pine Clear

Thermally Modified Thermotech Radiata Pine represents the application of advanced wood technology to the highest grade softwood for commercial application. Like all TFP Naturally Durable Hardwoods and Advanced Wood Technology Products, the elimination of chemical treatments means safety for the public and increased respect for the environment.

FASTENERS

Fasteners should be as strong and durable as the decking they are charged to hold down. First Developed for Atlantic City, Tropical Forest Products Boardwalk Screws represent the state of the art in Boardwalk Deck Connection. Boardwalk screws should be manufactured using

T-316 stainless steel heavy gauge wire to improve corrosion resistance. Heavy gauge and deep threads provide superior deck to stringer connections improving structural integrity and resistance to all nature has to dish out. While designed to outlast the decking that they hold down, their gauge and strength should allow for their easy removal and re-use should decking replacement be required. You know the old adage, "Anything worth doing is worth doing well" At Tropical Forest Products "We take life cycle performance very seriously"

5/4" x 4" and wider - Nominal Decking #8x2.5" (2 screws/connection point) 2" x 4" and wider - Nominal or Net Decking #10x3.5" (2 screws/connection point)
2" x 4" - Nominal or Net Decking may be installed #14x3.5" (1 screw at connection point) (Atlantic City Spec)
3" x 6" and wider - Nominal or Net Decking #14x6" (2 screws/connection point)
4" x 6" and wider – Nominal or Net Decking Typically Lag Screw or Through Bolted.
Boards should be pre-drilled and pre-countersunk before screw installation.

Then we have this monster— The Atlantic City Boardwalk Screw. 302 Stainless and Passivated for strength.

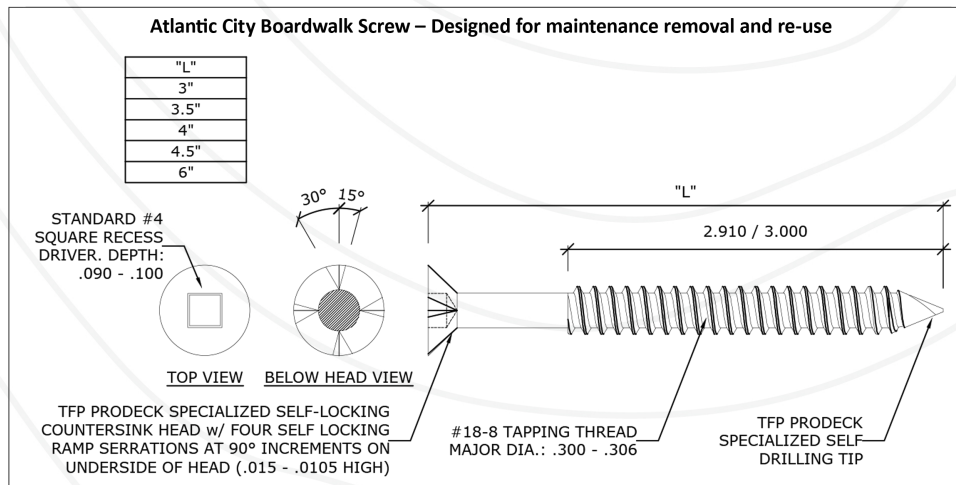

TROPICAL

6200 Tomken Rd Mississauga, ON - L5T 1X7 - Canada
1-855-344-4500 | www.TropicalForestProducts.com | info@tropicalforestproducts.com
© All Rights Reserved – Tropical Forest Products 2023



LEGAL LUMBER



TROPICAL

SELL SHEET

TROPICAL FOREST PRODUCTS
BOARDWALK DECKING

TECHNICAL DATA

Technical Data and CSI specification language for boardwalk decking including Mechanical Properties and Design Values including Decking, Stringer and Beam Span Charts are available upon request.

Having pioneered the naturally durable hardwood markets starting with our first installation in Atlantic City in 1971, Tropical Forest Products has developed the resources that engineers can rely on for heavy timber design and construction. For more information, please email us at technical@tfpwood.com or visit our website www.TropicalForestProducts.com



Omaha Bridge – Omaha, NE - Ipe



Duluth MN Lakewalk - Ipe



Freedom Park Naples, FL - Ipe

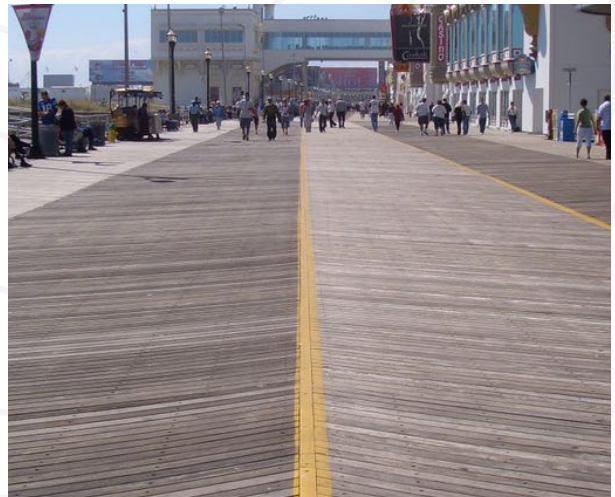

Atlantic City - Cumaru

TROPICAL

6200 Tomken Rd Mississauga, ON - L5T 1X7 - Canada
1-855-344-4500 | www.TropicalForestProducts.com | info@tropicalforestproducts.com
© All Rights Reserved – Tropical Forest Products 2023



LEGAL LUMBER™

